

 **KIACATU**®

KIACATU WATER PUMPS



 **KIACATU**®



**NANJING KEEFAR MACHINERY CO., LTD.**

Room 310, Huatong Science Park, #66 Software avenue, Yuhuatai District, Nanjing, China  
E-mail: [info@keefar.cn](mailto:info@keefar.cn)  
M.P./Wechat: 0086 136 0515 0236  
[www.keefar.cn](http://www.keefar.cn)

# 企业简介

## COMPANY PROFILE

Nanjing Keefar Machinery Co., Ltd. is specialized in wide variety of water pumps and accessories.

Our products are GS/EMC/CE/ROHS/UL/CUL approved by various certification authorities. With "satisfying customers need " as company operation vision, we always consider our customer's benefits as our top priority, and we are confident in providing our customers with more-than-satisfying solutions and services.

**QUALITY**  
**PRAGMATISM**  
**COLLABORATION**

品质/务实/协作





**Multi-stage clean water pump**



- 230V~50Hz
- Cable 10m
- Max. 1mm
- Max. 35°C
- 7m Max.

**IPX8**  
Protection

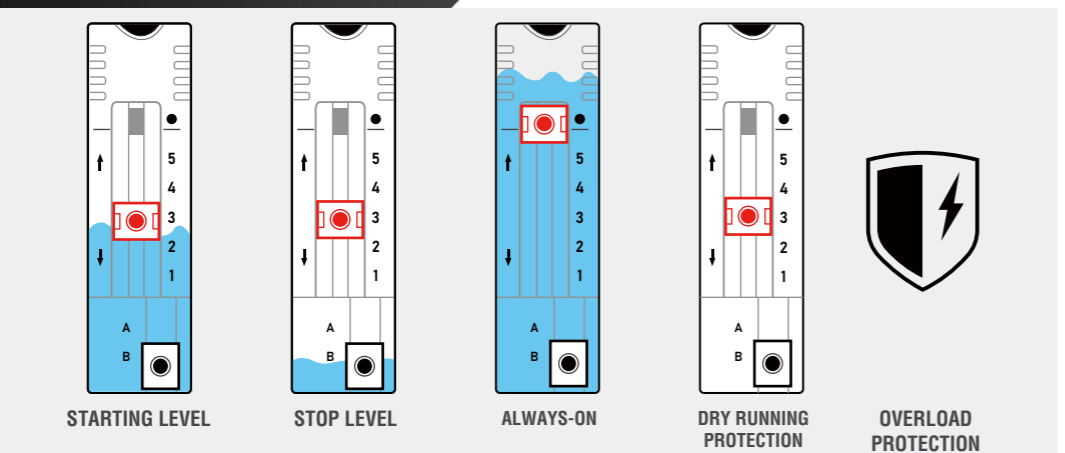

• NSPQ900-INOX3Pe / NSPQ1100-INOX4Pe



NSPQ900-3P  
NSPQ1100-4P

NSPQ900-INOX3P  
NSPQ1100-INOX4P

NSPQ900-INOX3Pe  
NSPQ1100-INOX4Pe

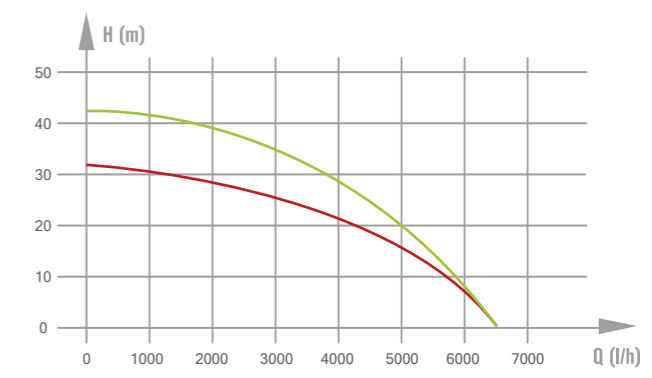

Model No.	Power	Max. pump rate (l/h)	Max. delivery height (m)	Dia. of Outlet pipe	Packing size (cm)	Carton size (cm)	Qty/ctn (pcs)	NW. /GW. (KG/CTN)
NSPQ900-3P	900W	6500	32	1"	23x19.5x40	41x25x42	2	14.1/15.6
NSPQ900-INOX3P	900W	6500	32					14.6/16.1
NSPQ900-INOX3Pe	900W	6500	32					14.7/16.2
NSPQ1100-4P	1100W	6500	42					15.6/17.1
NSPQ1100-INOX4P	1100W	6500	42	23x19.5x41	41x25x43			16.0/17.5
NSPQ1100-INOX4Pe	1100W	6500	42					16.2/17.7

	Qty/20'GP (pcs)	Qty/40'GP (pcs)	Qty/40'HQ (pcs)
NSPQ900-3P/INOX3P/INOX3Pe NSPQ1100-4P/INOX4P/INOX4Pe	1260	2610	3132



# 3-in-1 Submersible Water Pump

Dirty / Clean / Low-suction  
NSP3DXXX-K



230V~50Hz



Cable 10m



Max. 1/5/25mm



Max. 35°C

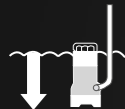

7m Max.

**IPX8**

Protection

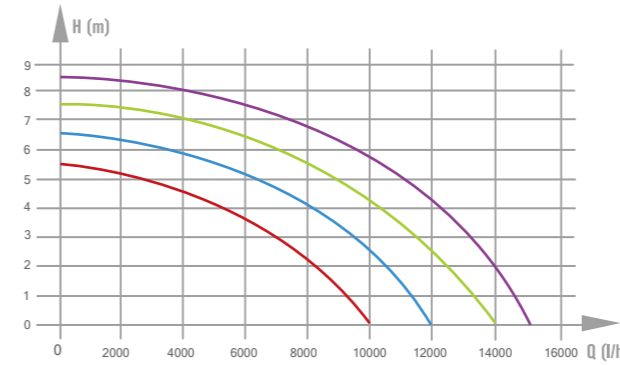

Model No.	Power	Max. pump rate (l/h)	Max. delivery height (m)	Dia. of Outlet pipe	Qty/ctn (pcs)	NW. /GW. (KG/CTN)	
NSP3D350-K	350W	10000	5.5	1" / 1-1/4"	4	13.30/17.5	
NSP3D400-K	400W	10000	5.5			13.30/17.5	
NSP3D450-K	450W	12000	6.5			16.30/19.1	
NSP3D500-K	500W	12000	6.5			16.30/19.1	
NSP3D550-K	550W	12000	6.5			16.30/19.1	
NSP3D650-K	650W	14000	7.5			17.90/20.70	
NSP3D750-K	750W	14000	7.5			17.90/20.70	
NSP3D850-K	850W	14000	7.5			17.90/20.70	
NSP3D900-K	900W	15000	8.5			19.10/21.90	
NSP3D950-K	950W	15000	8.5			19.10/21.90	
NSP3D1000-K	1000W	15000	8.5			19.10/21.90	
NSP3D1100-K	1100W	15000	8.5			19.10/21.90	



	Packing size (cm)	Carton size (cm)	Qty/20'GP (pcs)	Qty/40'GP (pcs)	Qty/40'HQ (pcs)
Clean / Dirty / Low-suction	24x17x33.5	50x36x35.5	1584	3312	3864
Clean / Dirty	21x17x33.5	44x36x35.5	1920	3840	4480
Low-suction	21x17x31.5	44x36x33.5	1920	3840	4480







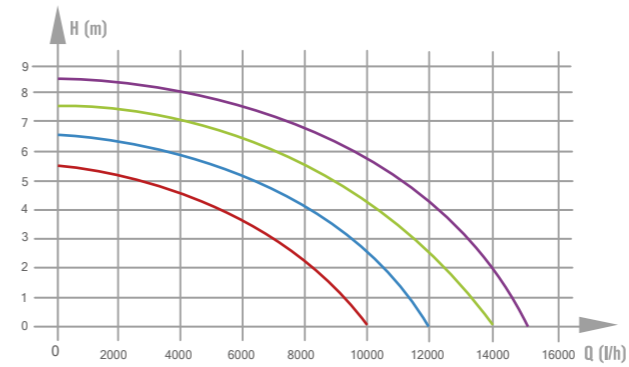

# 3-in-1 Submersible Water Pump

Dirty / Clean / Low-suction  
NSP3DXXX-Ke

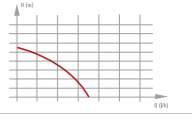
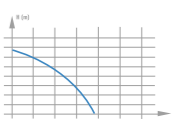

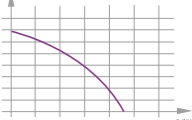
-  230V~50Hz
-  Cable 10m
-  Max. 1/5/25mm
-  Max. 35°C
-  7m Max.
- IPX8**  
Protection

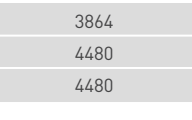

Model No.	Power	Max. pump rate (l/h)	Max. delivery height (m)	Dia. of Outlet pipe	Qty/ctn (pcs)	NW. /GW. (KG/CTN)	
NSP3D350-Ke	350W	10000	5.5	1" / 1-1/4"	4	13.30/17.5	
NSP3D400-Ke	400W	10000	5.5			13.30/17.5	
NSP3D450-Ke	450W	12000	6.5			16.30/19.1	
NSP3D500-Ke	500W	12000	6.5			16.30/19.1	
NSP3D550-Ke	550W	12000	6.5			16.30/19.1	
NSP3D650-Ke	650W	14000	7.5			17.90/20.70	
NSP3D750-Ke	750W	14000	7.5			17.90/20.70	
NSP3D850-Ke	850W	14000	7.5			17.90/20.70	
NSP3D900-Ke	900W	15000	8.5			19.10/21.90	
NSP3D950-Ke	950W	15000	8.5			19.10/21.90	
NSP3D1000-Ke	1000W	15000	8.5			19.10/21.90	
NSP3D1100-Ke	1100W	15000	8.5			19.10/21.90	

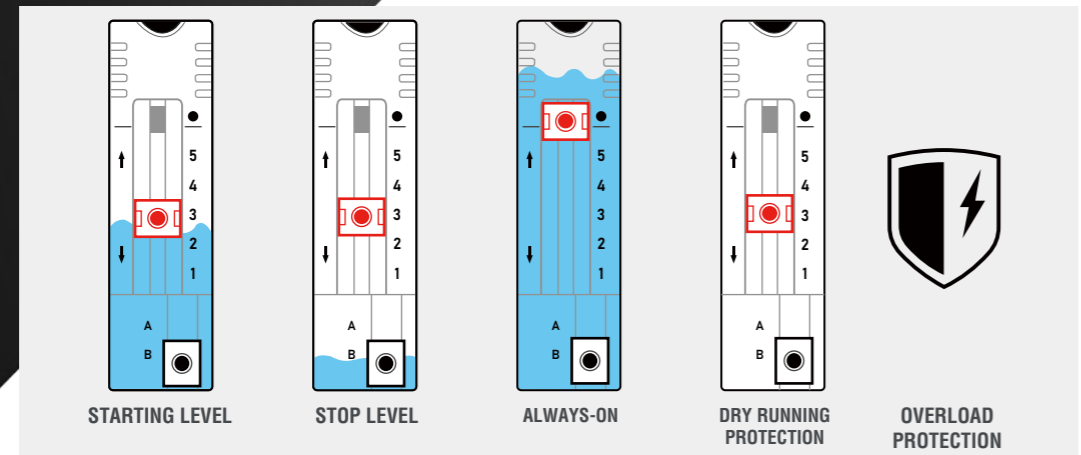

	Packing size (cm)	Carton size (cm)	Qty/20'GP (pcs)	Qty/40'GP (pcs)	Qty/40'HQ (pcs)
Clean / Dirty / Low-suction	24x17x33.5	50x36x35.5	1584	3312	3864
Clean / Dirty	21x17x33.5	44x36x35.5	1920	3840	4480
Low-suction	21x17x31.5	44x36x33.5	1920	3840	4480



# Inox Dirty Water Pump

**NSPWXXX-INOX2e**

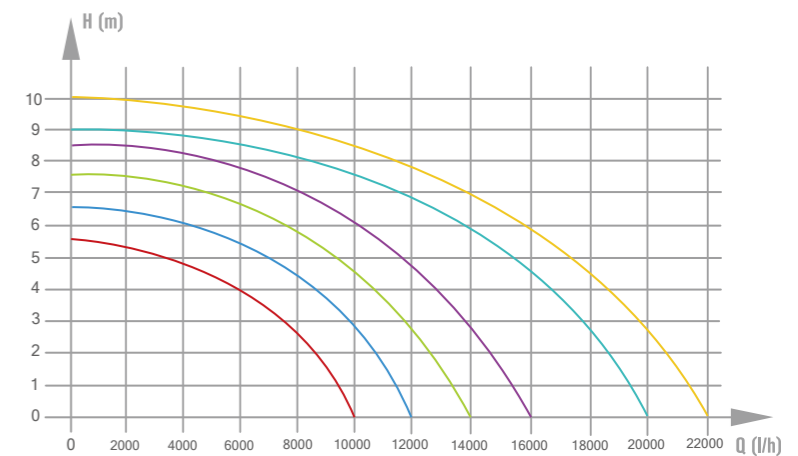

230V~50Hz



Cable 10m



Max. 35mm



Max. 35°C

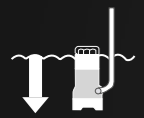

7m Max.

**IPX8**

Protection

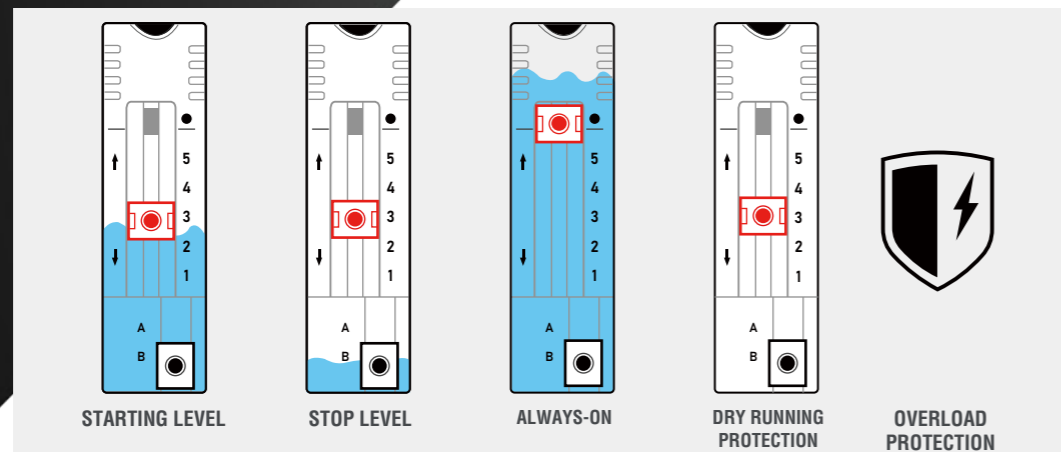

Model No.	Power	Max. pump rate (l/h)	Max. delivery height (m)	Dia. of Outlet pipe	Packing size (cm)	Carton size (cm)	Qty/ctn (pcs)	NW. /GW. (KG/CTN)	
NSPW350-INOX2e	350W	10000	5.5	1" 1-1/4" 1-1/2"	22x17x37.5	46x36x39.5	4	22.32/23.20	
NSPW400-INOX2e	400W	10000	5.5					22.32/23.20	
NSPW450-INOX2e	450W	12000	6.5					23.72/24.60	
NSPW500-INOX2e	500W	12000	6.5					23.72/24.60	
NSPW550-INOX2e	550W	12000	6.5					23.72/24.60	
NSPW650-INOX2e	650W	14000	7.5					24.75/25.63	
NSPW750-INOX2e	750W	14000	7.5					24.75/25.63	
NSPW850-INOX2e	850W	14000	7.5					24.75/25.63	
NSPW900-INOX2e	900W	16000	8.5					26.25/27.13	
NSPW1000-INOX2e	1000W	20000	9					27.71/28.59	
NSPW1100-INOX2e	1100W	20000	9					27.71/28.59	
NSPW1200-INOX2e	1200W	22000	10					27.74/28.66	

Qty/20'GP (pcs)	Qty/40'GP (pcs)	Qty/40'HQ (pcs)
1600	3200	3840



# Inox Dirty Water Pump

**NSPWXXX-INOXB2e**



230V~50Hz

Cable 10m

Max. 30mm

Max. 35°C

7m Max.

**IPX8**  
Protection

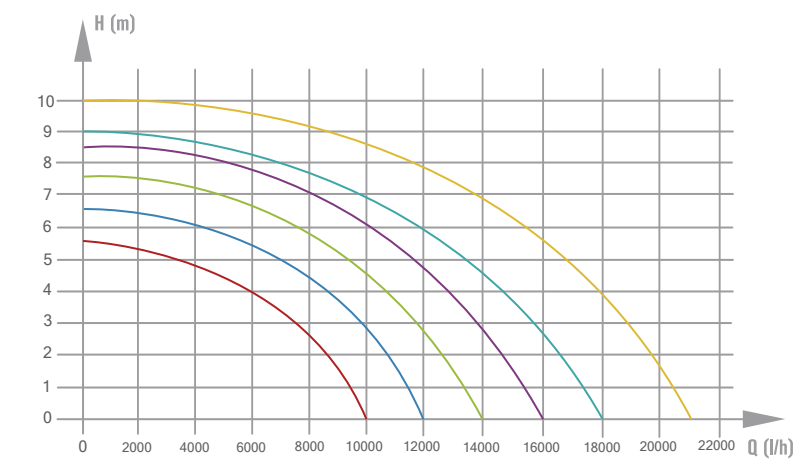

Model No.	Power	Max. pump rate (l/h)	Max. delivery height (m)	Dia. of Outlet pipe	Packing size (cm)	Carton size (cm)	Qty/ctn (pcs)	NW. /GW. (KG/CTN)	
NSPW350-INOXB2e	350W	10000	5.5	1" 1-1/4" 1-1/2"	22x17x37.5	46x36x39.5	4	22.62/23.32	
NSPW400-INOXB2e	400W	10000	5.5					22.62/23.32	
NSPW450-INOXB2e	450W	12000	6.5					24.02/24.72	
NSPW500-INOXB2e	500W	12000	6.5					24.02/24.72	
NSPW550-INOXB2e	550W	12000	6.5					24.02/24.72	
NSPW650-INOXB2e	650W	14000	7.5					25.05/25.75	
NSPW750-INOXB2e	750W	14000	7.5					25.05/25.75	
NSPW850-INOXB2e	850W	14000	7.5					25.05/25.75	
NSPW900-INOXB2e	900W	16000	8.5					26.56/27.26	
NSPW1000-INOXB2e	1000W	18000	9					28.01/28.71	
NSPW1100-INOXB2e	1100W	18000	9					28.01/28.71	
NSPW1200-INOXB2e	1200W	21000	10					28.80/29.60	

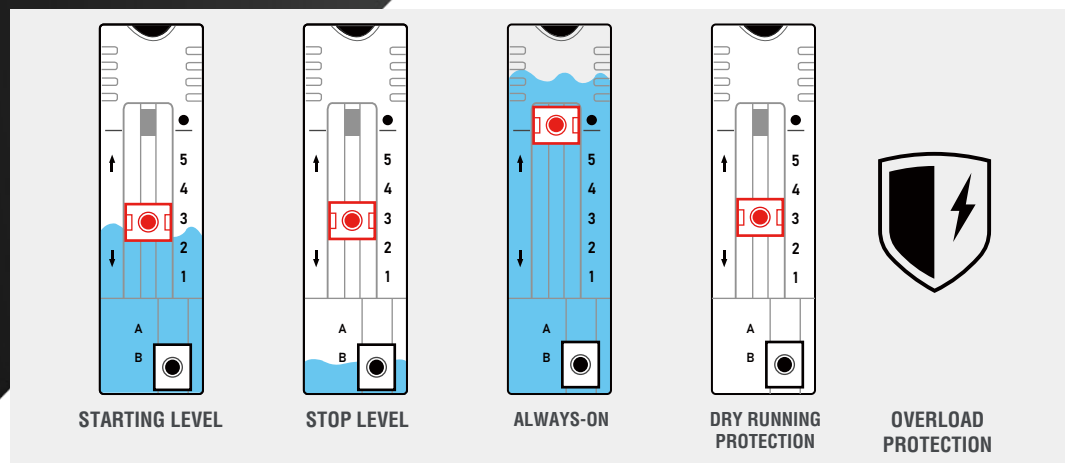

Qty/20'GP (pcs)	Qty/40'GP (pcs)	Qty/40'HQ (pcs)
1600	3200	3840



**Inox Clean Water Pump**

**NSPQXXX-INOXSe**

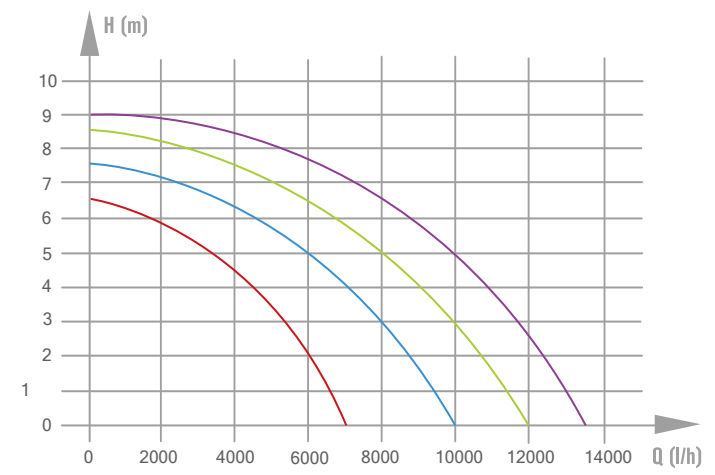

230V~50Hz

Cable 10m

Max. 5mm

Max. 35°C

7m Max.

**IPX8**  
Protection

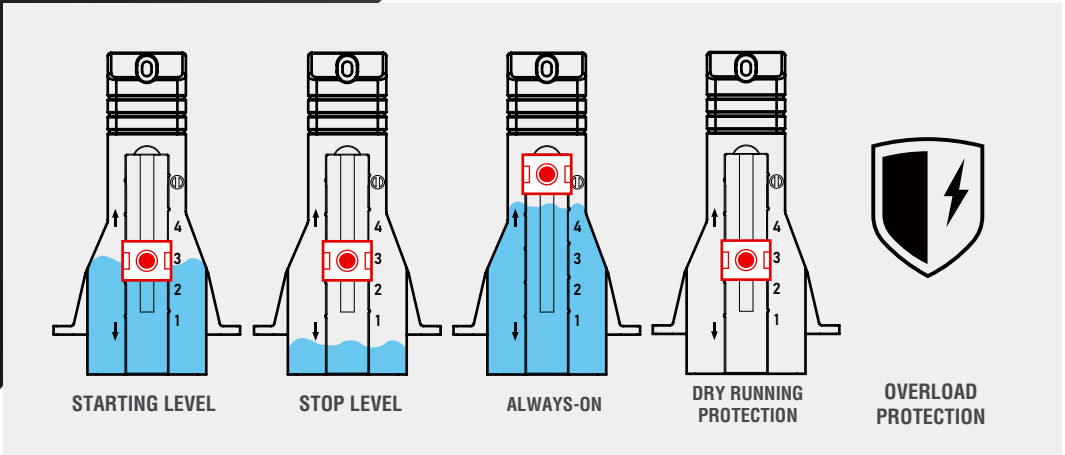

Model No.	Power	Max. pump rate (l/h)	Max. delivery height (m)	Dia. of Outlet pipe	Packing size (cm)	Carton size (cm)	Qty/ctn (pcs)	NW. /GW. (KG/CTN)	
NSPQ350-INOXSe	350W	9000	6.5	1" 1-1/4" 1-1/2"	22x16x31	46x34x33	4	15.10/15.70	
NSPQ400-INOXSe	400W	9000	6.5					15.10/15.70	
NSPQ450-INOXSe	450W	10000	7.5					16.51/17.11	
NSPQ500-INOXSe	500W	10000	7.5					16.51/17.11	
NSPQ550-INOXSe	550W	10000	7.5					16.51/17.11	
NSPQ650-INOXSe	650W	12000	8.5					17.83/18.43	
NSPQ750-INOXSe	750W	12000	8.5					17.83/18.43	
NSPQ850-INOXSe	850W	12000	8.5					17.83/18.43	
NSPQ900-INOXSe	900W	13500	9					19.35/19.95	
NSPQ1000-INOXSe	1000W	13500	9					19.35/19.95	
NSPQ1100-INOXSe	1100W	13500	9					19.35/19.95	

Qty/20'GP (pcs)	Qty/40'GP (pcs)	Qty/40'HQ (pcs)
2100	4200	4900



**Clean Water Pump**

**ZSPQDXXX-E**

230V~50Hz

Cable 10m

Max. 1mm

Max. 35°C

7m Max.

**IPX8**  
Protection

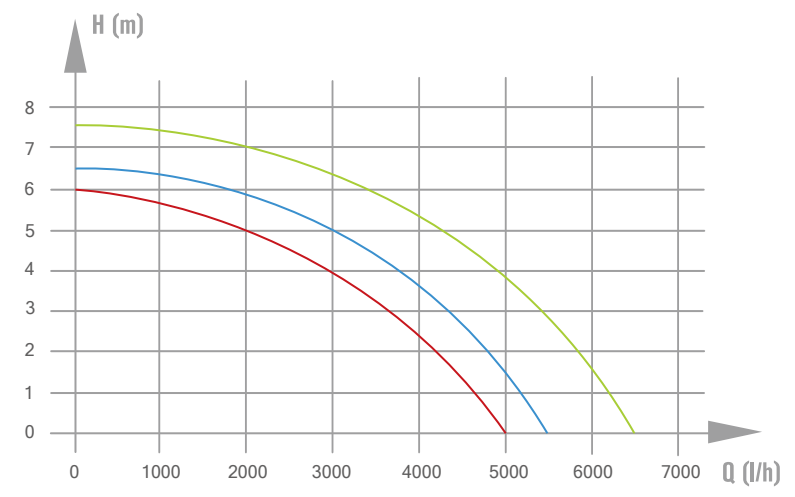

Model No.	Power	Max. pump rate (l/h)	Max. delivery height (m)	Dia. of Outlet pipe	Packing size (cm)	Carton size (cm)	Qty/ctn (pcs)	NW./GW. (KG/CTN)	
ZSPQD250-E	250W	5000	6	1" 1-1/4" 1-1/2"	20x16.5x30	42x35x32	4	14.80/15.40	
ZSPQD300-E	300W	5000	6					14.80/15.40	
ZSPQD350-E	350W	5000	6					14.80/15.40	
ZSPQD400-E	400W	5500	6.5					15.84/16.44	
ZSPQD450-E	450W	5500	6.5					15.84/16.44	
ZSPQD500-E	500W	6500	7.5					16.66/17.26	
ZSPQD550-E	550W	6500	7.5					16.66/17.26	

Qty/20'GP (pcs)	Qty/40'GP (pcs)	Qty/40'HQ (pcs)
2240	4480	5200



**Dirty Water Pump**

**NSPWXXX-H**



230V~50Hz

Cable 10m

Max. 25mm

Max. 35°C

7m Max.

**IPX8**  
Protection

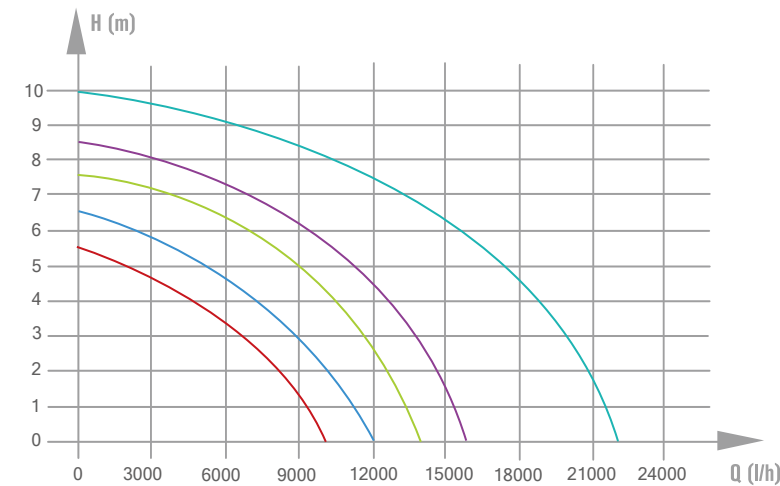

Model No.	Power	Max. pump rate (l/h)	Max. delivery height (m)	Dia. of Outlet pipe	Packing size (cm)	Carton size (cm)	Qty/ctn (pcs)	NW. /GW. (KG/CTN)	
NSPW350-H	350W	10000	5.5	1" 1-1/4" 1-1/2"	21x18x39	44x38x41	4	17.30/18.00	
NSPW400-H	400W	10000	5.5					17.30/18.00	
NSPW450-H	450W	12000	6.5					19.40/20.10	
NSPW500-H	500W	12000	6.5					19.40/20.10	
NSPW550-H	550W	12000	6.5					20.60/21.30	
NSPW650-H	650W	14000	7.5					20.60/21.30	
NSPW750-H	750W	14000	7.5					20.60/21.30	
NSPW850-H	850W	14000	7.5					20.60/21.30	
NSPW900-H	900W	15000	7.5					20.60/21.30	
NSPW950-H	950W	16000	8.5					22.20/22.90	
NSPW1000-H	1000W	16000	8.5					22.20/22.90	
NSPW1100-H	1100W	16000	8.5					22.20/22.90	
NSPW1200-H	1200W	22000	10					22.90/23.60	

Qty/20'GP (pcs)	Qty/40'GP (pcs)	Qty/40'HQ (pcs)
1560	3120	3744



**Clean Water Pump**

**NSPQXXX-H**



230V~50Hz



Cable 10m



Max. 5mm



Max. 35°C

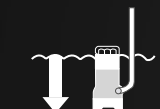

7m Max.

**IPX8**

Protection

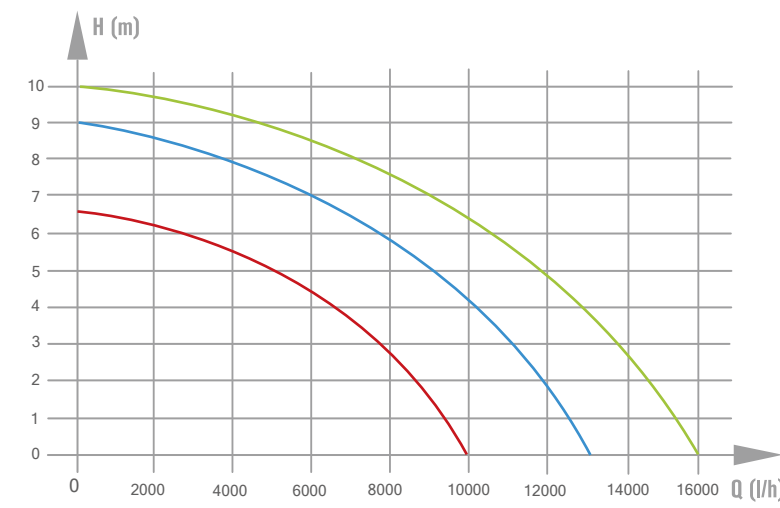

Model No.	Power	Max. pump rate (l/h)	Max. delivery height (m)	Dia. of Outlet pipe	Packing size (cm)	Carton size (cm)	Qty/ctn (pcs)	NW. /GW. (KG/CTN)	
NSPQ400-H	400W	10000	6.5	1" 1-1/4" 1-1/2"	21x18x38	44x38x40	4	18.5/20.6	
NSPQ750-H	750W	13000	9					19.0/21.3	
NSPQ900-H	900W	16000	10					19.4/21.6	

Qty/20'GP (pcs)	Qty/40'GP (pcs)	Qty/40'HQ (pcs)
1560	3120	3744



**Clean Water Pump**

**NSPQXXX-C**

  
230V~50Hz

  
Cable 10m







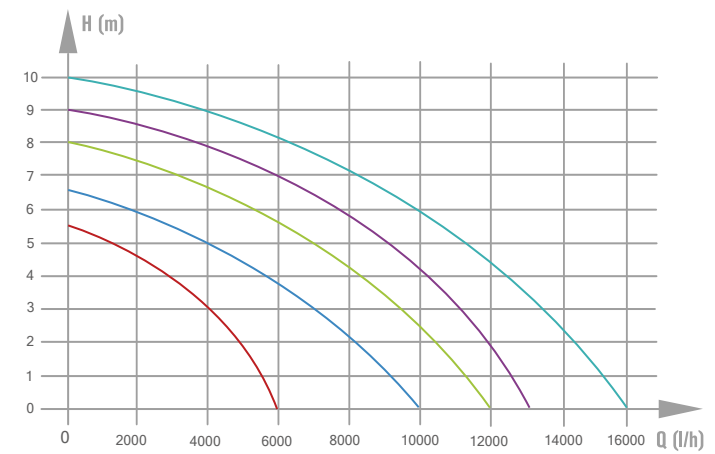

  
Max. 5mm

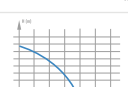
  
Max. 35°C

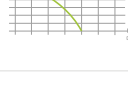
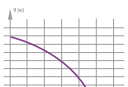
  
7m Max.

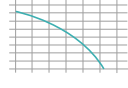
**IPX8**  
Protection



Model No.	Power	Max. pump rate (l/h)	Max. delivery height (m)	Dia. of Outlet pipe	Packing size (cm)	Carton size (cm)	Qty/ctn (pcs)	NW. /GW. (KG/CTN)	
NSPQ250 -C	250W	6000	5.5	1" 1-1/4" 1-1/2"	21x17x31.5	44x36x33.5	4	15.25/15.81	
NSPQ300 -C	300W	6000	5.5					15.25/15.81	
NSPQ350 -C	350W	10000	6.5					16.37/16.93	
NSPQ400 -C	400W	10000	6.5					16.37/16.93	
NSPQ450 -C	450W	12000	8					17.78/18.34	
NSPQ500 -C	500W	12000	8					17.78/18.34	
NSPQ550 -C	550W	12000	8					17.78/18.34	
NSPQ650 -C	650W	13000	9					19.10/19.66	
NSPQ750 -C	750W	13000	9					19.10/19.66	
NSPQ850 -C	850W	13000	9					19.10/19.66	
NSPQ900 -C	900W	16000	10					20.62/21.18	
NSPQ950 -C	950W	16000	10					20.62/21.18	
NSPQ1000 -C	1000W	16000	10	20.62/21.18					
NSPQ1100 -C	1100W	16000	10	20.62/21.18					

Qty/20'GP (pcs)	Qty/40'GP (pcs)	Qty/40'HQ (pcs)
1920	3840	4480



**Dirty Water Pump**

**NSPWXXX-C**



230V~50Hz

Cable 10m

Max. 25mm

Max. 35°C

7m Max.

**IPX8**  
Protection

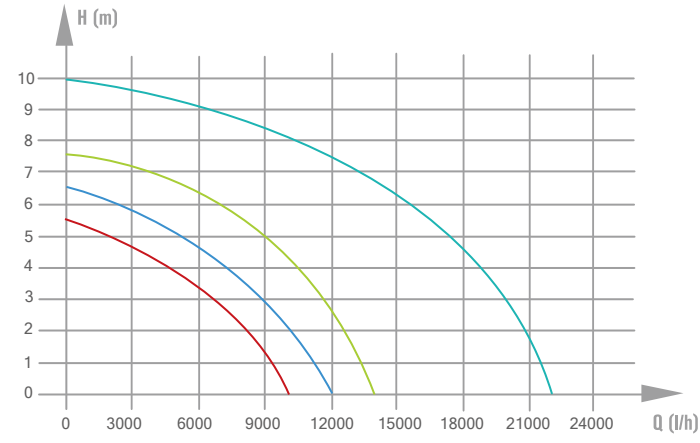

Model No.	Power	Max. pump rate (l/h)	Max. delivery height (m)	Dia. of Outlet pipe	Packing size (cm)	Carton size (cm)	Qty/ctn (pcs)	NW. /GW. (KG/CTN)	
NSPW350-C	350W	10000	5.5	1" 1-1/4" 1-1/2"	21x17x34.5	44x36x36.5	4	16.52/17.12	
NSPW400-C	400W	12000	6.5					17.30/17.90	
NSPW450-C	450W	12000	6.5					17.30/17.90	
NSPW500-C	500W	12000	6.5					17.30/17.90	
NSPW550-C	550W	12000	6.5					17.30/17.90	
NSPW650-C	650W	14000	7.5					18.95/19.55	
NSPW750-C	750W	14000	7.5					18.95/19.55	
NSPW850-C	850W	14000	7.5					18.95/19.55	
NSPW900-C	900W	16000	7.5					18.95/19.55	
NSPW950-C	950W	16000	7.5					18.95/19.55	
NSPW1000-C	1000W	16000	7.5					18.95/19.55	
NSPW1100-C	1100W	16000	7.5					18.95/19.55	
NSPW1200-C	1200W	22000	10	21.80/22.40					

Qty/20'GP (pcs)	Qty/40'GP (pcs)	Qty/40'HQ (pcs)
1920	3840	4480



**Clean Water Pump**

**ZSPQXXX-G**

  
230V~50Hz

  
Cable 10m



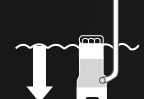

  
Max. 5mm

  
Max. 35°C

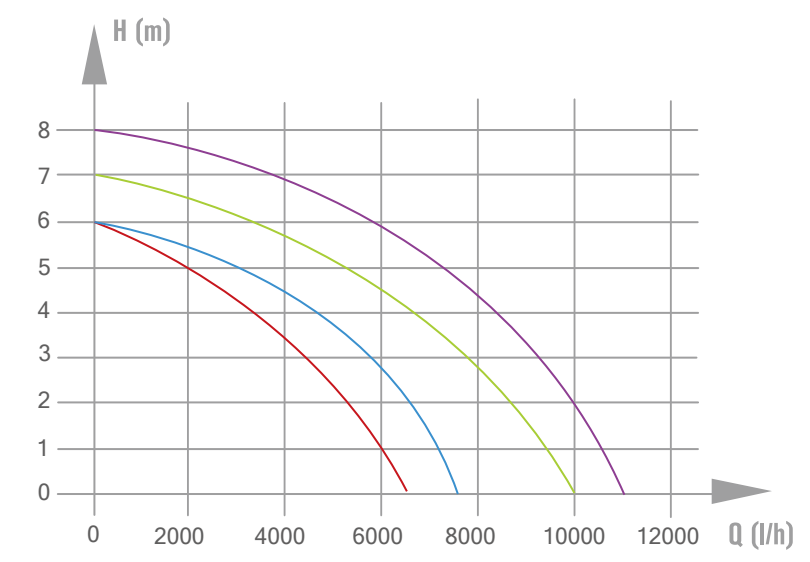
  
7m Max.

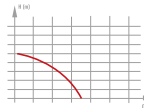
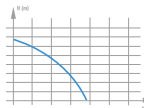
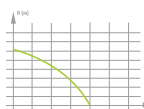
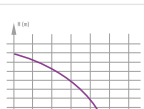
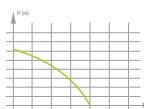
**IPX8**  
Protection

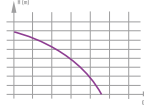

Model No.	Power	Max. pump rate (l/h)	Max. delivery height (m)	Dia. of Outlet pipe	Packing size (cm)	Carton size (cm)	Qty/ctn (pcs)	NW. /GW. (KG/CTN)	
ZSPQ250 -G	250W	6500	6	1" 1-1/4" (KF-NSPQXXX -D/G)	19x15x30	40x32x32	4	14.24/14.80	
ZSPQ300 -G	300W	6500	6					14.24/14.80	
ZSPQ350 -G	350W	7500	6					14.24/14.80	
ZSPQ400 -G	400W	7500	6					14.24/14.80	
ZSPQ450 -G	450W	10000	7	1-1/4" 1-1/2" (KF-NSPQXXX -D1)			15.27/15.83		
ZSPQ500 -G	500W	10000	7				15.27/15.83		
ZSPQ550 -G	550W	11000	8				16.10/16.66		
ZSPQ600 -G	600W	11000	8				16.10/16.66		

Qty/20'GP (pcs)	Qty/40'GP (pcs)	Qty/40'HQ (pcs)
2744	5684	6496



**Dirty Water Pump**

**ZSPWXXX-G**

230V~50Hz

Cable 10m

Max. 25mm

Max. 35°C

7m Max.

**IPX8**  
Protection

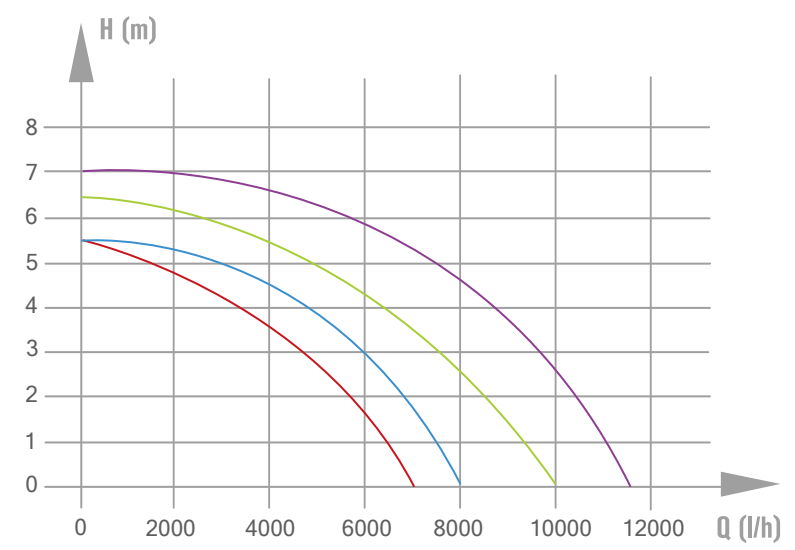

Model No.	Power	Max. pump rate (l/h)	Max. delivery height (m)	Dia. of Outlet pipe	Packing size (cm)	Carton size (cm)	Qty/ctn (pcs)	NW. /GW. (KG/CTN)	
ZSPW250-G	250W	7000	5.5	1" 1-1/4" (KF-ZSPWXXX -D/G)	19x15x30	40x32x32	4	14.14/14.70	
ZSPW300-G	300W	7000	5.5					14.14/14.70	
ZSPW350-G	350W	8000	5.5	1" 1-1/4" 1-1/2" (KF-ZSPWXXX -D1)	19x15x30	40x32x32	4	14.14/14.70	
ZSPW400-G	400W	8000	5.5					14.14/14.70	
ZSPW450-G	450W	10000	6.5	15.18/15.74	15.18/15.74	15.18/15.74	15.18/15.74		
ZSPW500-G	500W	10000	6.5					15.18/15.74	
ZSPW550-G	550W	11500	7	16.00/16.58	16.00/16.58	16.00/16.58	16.00/16.58		
ZSPW600-G	600W	11500	7					16.00/16.58	

Qty/20'GP (pcs)	Qty/40'GP (pcs)	Qty/40'HQ (pcs)
2744	5684	6496



230V~50Hz



Cable 1.2m



Max. 1mm



Max. 35°C



8m Max.

**IPX4**

Protection



**Garden Pump**

**NGPXXXF- S / INOX / T1**

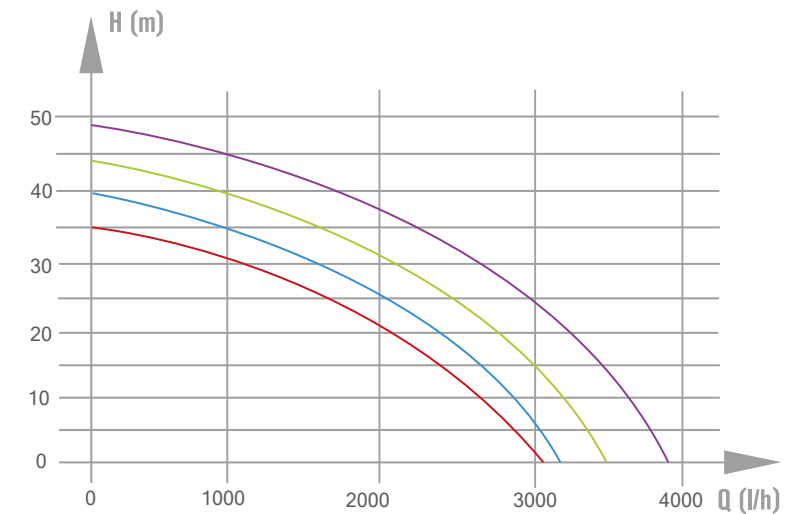

Model No.	Power	Max. pump rate (l/h)	Max. delivery height (m)	Dia. of Outlet pipe	Packing size (cm)	Carton size (cm)	Qty/ctn (pcs)	NW. /GW. (KG/CTN)	
NGP600F-S/INOX/T1	600W	3100	35	1"	36.5x24x21.5	36.5x24x21.5	1	5.30/5.78 5.35/5.83 8.60/9.08	
NGP800F-S/INOX/T1	800W	3300	40					5.50/5.98 5.55/6.03 8.80/9.28	
NGP1000F-S/INOX/T1	1000W	3500	44					5.95/6.38 5.95/6.43 9.20/9.68	
NGP1200F-S/INOX/T1	1200W	3800	48					6.10/6.58 6.15/6.63 9.40/9.88	

	Qty/20'GP (pcs)	Qty/40'GP (pcs)	Qty/40'HQ (pcs)
NGPXXXF-S/INOX	1380	2880	3380
NGPXXXF-T1	1380	/	/



**Garden Pump**

**NGPXXXE- SPC / T1PC / INOXGC**

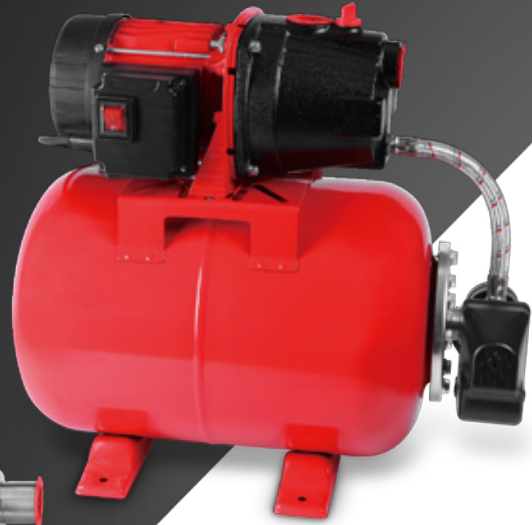
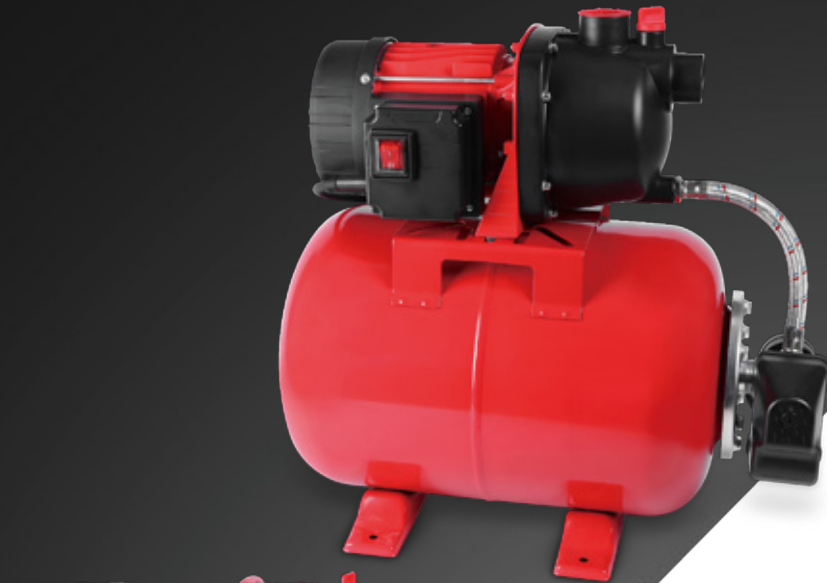
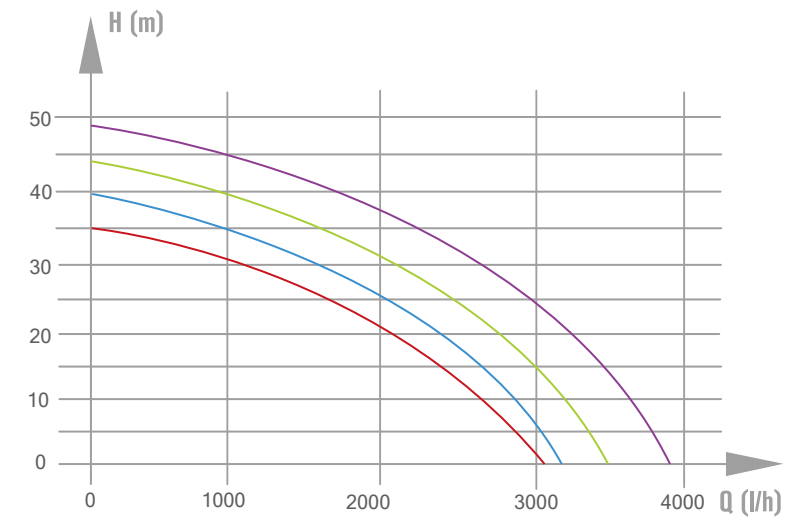

230V~50Hz



Cable 1.2m



Max. 1mm



MaC 35



8m Max.

**IPX4**

Protection



19l / 24l

Model No.	Power	Max. pump rate (l/h)	Max. delivery height (m)	Dia. of Outlet pipe	Packing size (cm)	Carton size (cm)	Qty/ctn (pcs)	NW. /GW. (KG/CTN)	
NGP600E-SPC/T1PC/INOXGC	600W	3100	35	1"	49x28.5x52.5 (19l) 55x28.5x52.5 (24l)	49x28.5x52.5 (19l) 55x28.5x52.5 (24l)	1	10.12/11.18 10.17/11.23 13.42/14.48	
NGP800E-SPC/T1PC/INOXGC	800W	3300	40					10.32/11.38 10.37/11.43 13.62/14.68	
NGP1000E-SPC/T1PC/INOXGC	1000W	3500	44					10.72/11.78 10.77/11.83 14.02/15.08	
NGP1200E-SPC/T1PC/INOXGC	1200W	3800	48					10.92/11.98 10.97/12.03 14.22/15.28	

	Qty/20'GP (pcs)	Qty/40'GP (pcs)	Qty/40'HQ (pcs)
19l	352	736	920
24l	320	672	840



**Garden Pump**

**DGPXXXD1- INOX2 / S2**

  
230V~50Hz

  
Cable 1.2m

  
Max. 1mm

  
Max. 35°C

  
8m Max.

**IPX4**  
Protection

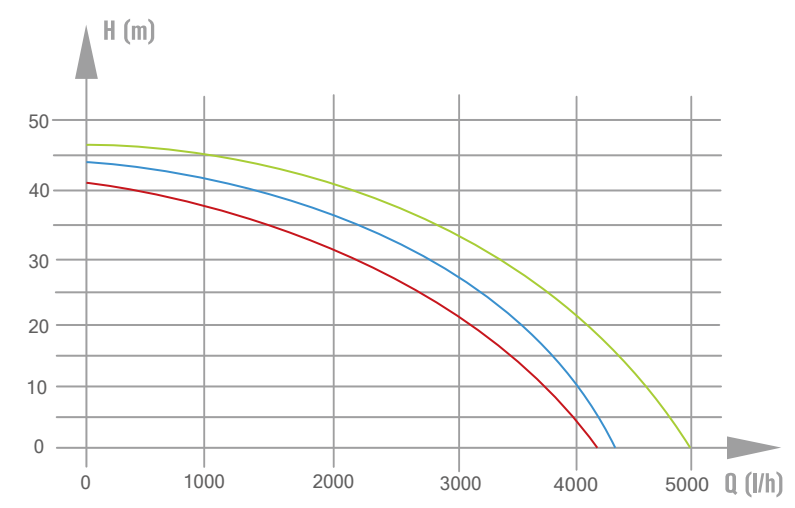

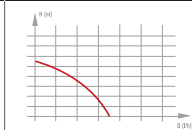
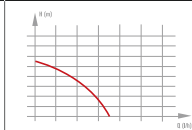
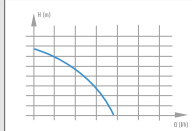
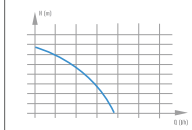
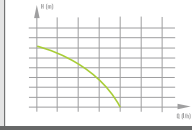
Model No.	Power	Max. pump rate (l/h)	Max. delivery height (m)	Dia. of Outlet pipe	Packing size (cm)	Carton size (cm)	Qty/ctn (pcs)	NW. /GW. (KG/CTN)	
DGP900D1-INOX2/S2	900W	4200	41	1"	38.5x26x25.5	38.5x26x25.5	1	8.00/8.90	
DGP1000D1-INOX2/S2	1000W	4300	44						
DGP1100D1-INOX2/S2	1100W	4300	44						
DGP1300D1-INOX2/S2	1300W	5000	46						

Qty/20'GP (pcs)	Qty/40'GP (pcs)	Qty/40'HQ (pcs)
1080	2160	2640

# • Pressure Switch



EPC-1			
Rated Voltage	220-240V	110-120V	110-240V
Power Frequency	50/60Hz	50/60Hz	50/60Hz
Max Power	1.1kW/1.5kW	0.55kW	0.55kW/1.1kW
Starting Pressure Setting	1.2bar, 1.5bar, 2.2bar	1.2bar, 1.5bar, 2.2bar	1.2bar, 1.5bar, 2.2bar
Max Working Pressure	10bar	10bar	10bar
Connection Thread	G1", G1 1/4", G1 1/2", NPT1"	G1", G1 1/4", G1 1/2", NPT1"	G1", G1 1/4", G1 1/2", NPT1"
Protection Rating	IP65	IP65	IP65
Max Working Temperature	55°C	55°C	55°C



EPC-2			
Rated Voltage	220-240V	110-120V	110-240V
Power Frequency	50/60Hz	50/60Hz	50/60Hz
Max Power	1.1kW	0.55kW	0.55kW/1.1kW
Starting Pressure Setting	1.2bar, 1.5bar, 2.2bar	1.2bar, 1.5bar, 2.2bar	1.2bar, 1.5bar, 2.2bar
Max Working Pressure	10bar	10bar	10bar
Connection Thread	R1"	R1"	R1"
Protection Rating	IP65	IP65	IP65
Max Working Temperature	55°C	55°C	55°C



EPC-4			
Rated Voltage	220-240V	110-120V	110-240V
Power Frequency	50/60Hz	50/60Hz	50/60Hz
Max Power	1.1kW	0.55kW	0.55kW/1.1kW
Starting Pressure Setting	1.2bar, 1.5bar, 2.2bar	1.2bar, 1.5bar, 2.2bar	1.2bar, 1.5bar, 2.2bar
Max Working Pressure	10bar	10bar	10bar
Connection Thread	G1"	G1"	G1"
Protection Rating	IP65	IP65	IP65
Max Working Temperature	55°C	55°C	55°C



EPC-5			
Rated Voltage	220-240V	110-120V	110-240V
Power Frequency	50/60Hz	50/60Hz	50/60Hz
Max Power	1.1kW	0.55kW	0.55kW/1.1kW
Starting Pressure Setting	1.2bar, 1.5bar, 2.2bar	1.2bar, 1.5bar, 2.2bar	1.2bar, 1.5bar, 2.2bar
Max Working Pressure	10bar	10bar	10bar
Connection Thread	G1"	G1"	G1"
Protection Rating	IP65	IP65	IP65
Max Working Temperature	55°C	55°C	55°C



EPC-10		
Rated Voltage	110-240V	
Power Frequency	50/60Hz	
Starting Pressure Setting	0.5-6.7bar	
Stopping Pressure Setting	0.8-7.0bar	
Delay startup Settings	0.1-1H, 1-24H	
Max Working Pressure	1.0Mpa	
Screw Type	Female	male
Screw Size	Fix Nut: 1/4" 3/8" Rotary: 1/4"	1/4"
Protection Rating	IP65	
Max Working Temperature	55°C	

# • Watering Kit



HPA-01



HPA-02

Model No.	HPA-01	HPA-02
Quick connector	3/4" / Ø19mm	1" / Ø25.4mm
Water stop quick connector	3/4" / Ø19mm	1" / Ø25.4mm
Hose nozzle	Ø15mm	Ø19mm
Tap adaptor	3/4" / Ø19mm & 1" / Ø25.4mm	1" / Ø25.4mm & 1" / Ø25.4mm

## • Pressure Switch



KRS-2		
Rated Voltage	110-240V	
Power Frequency	50/60Hz	
Rated Current	10(4)A	
Min.cut-in	0.5bar	
Max.cut-out	3.5bar	
Pressure Range	1.0-1.8bar,1.5-2.2bar,2.2-3.0bar etc.	
Bases	Zin Alloy	Plastic
Contacts	Double	Singe
Screw Type	Female	male
Screw Szie	1/4",3/8"	1/4",3/8"
Protection Rating	IP20	
Max Working Temperature	55°C	



KRS-3		
Rated Voltage	110-240V	
Power Frequency	50/60Hz	
Rated Current	12A	
Min.cut-in	20PSI	
Max.cut-out	100PSI	
Pressure Range	20-40PSI,30-50PSI,40-60PSI,50-70PSI	
Flange	Steel,Plastic	
Screw Type	Female	male
Screw Szie	Fix Nut:1/4"3/8" Rotary:1/4"3/8"	1/4",3/8"
Protection Rating	IP20	
Max Working Temperature	55°C	

## • Suction Hose



**SG01**



**SG02**



**SG03**



**SG04**

Model No.	SG01	SG02	SG03	SG04
Length	7m	7m	7m	20m
Main material	PVC	PVC	PVC	PVC
Inner/Outer Dia	Φ22 / Φ27mm	Φ25.4 / Φ30mm	Φ22 / Φ27mm	Φ15 / Φ21mm
Working pressure	3bar	3bar	4bar	7bar
Max. burst pressure	8bar	8bar	10bar	21bar
Check valve	ABS	ABS	ABS	NA

## • Pressure Gauge



**PG-1**



**PG-2**

Model No.	PG-1	PG-2
Outlet	0-6/0-10/0-16bar	0-6/0-10/0-16bar
Pressure	Matal	Matal
Watch Case	Plastic	Plastic
Corrector	50mm Axial Z1/4	60mm Radial Z1/4

### • Brass Strainer With Check Valve



**HT001**

Female / Female thread Ø 25.4 MM

### • Brass Check Valve



**HT002**

Female / Female thread Ø 25.4 MM

### • 3-way Brass Fitting



**HT003**

1 male / 2 females Thread:Ø33.3 mm

## • Connector

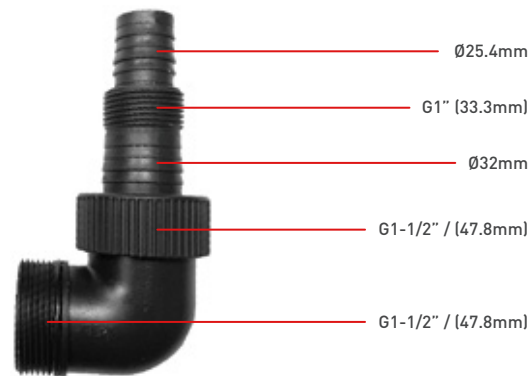

Outlet	Connector
G1-1/2"	1"/G1"/1-1/4"/G1-1/2"

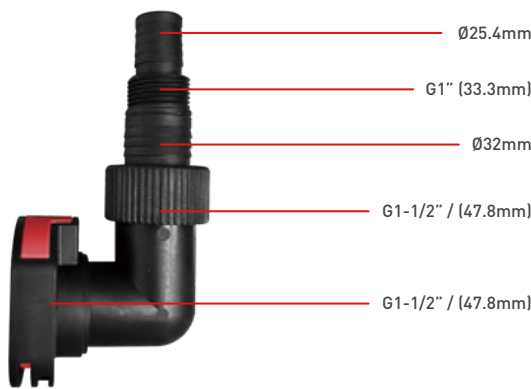

Outlet	Connector
G1-1/2"	1"/G1"/1-1/4"/G1-1/2"

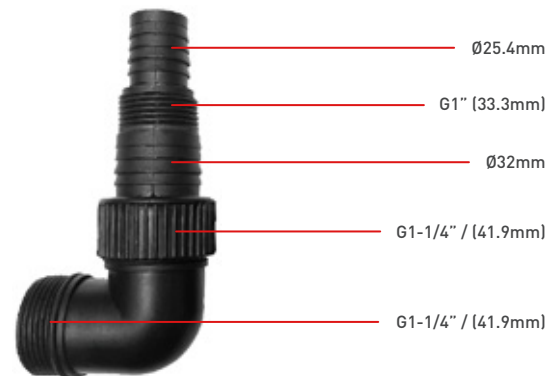

Outlet	Connector
G1-1/4"	1"/G1"/1-1/4"/G1-1/4"



Connector
1"

## • Lay flat water hose



Model No.	Diameter	Length	Materials
SD01	25mm	10m	PVC
SD02	25mm	25m	PVC
SD03	32mm	10m	PVC
SD04	32mm	25m	PVC
SD05	40mm	10m	PVC
SD06	40mm	25m	PVC
SD07	50mm	10m	PVC
SD08	50mm	25m	PVC

## • Water filter



Q16

J5



Q10-A-1

J5-1

## • Floating switch



FSS

FSR

## • Clamp



Model No.	Q16	J5
Connectin thread	1"	1"
Max operating pressure	10Bar	10Bar
Max temperature	40°C	40°C
Filter element length	25cm	12cm

Model No.	Q10-A-1	J5-1
Max temperature	40°C	40°C
Filter element length	25cm	12cm

Model No.	FSS	FSR
Volt.&Freq	250V-50Hz	250V-50Hz
IP Class	IP68	IP68

Model No.	C01	C02	C03
Range	22-32mm	26-38mm	32-44mm
Suitable hose diameter	25mm	32mm	38mm

